

320018A001

PL: Stół piknikowy

EN: Picnic table

FR: Table de pique-nique

DE: Picknicktisch

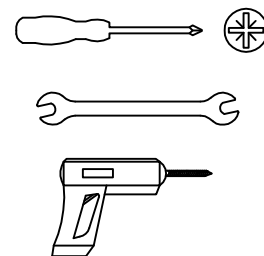
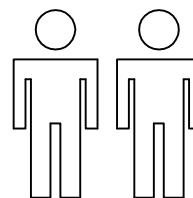
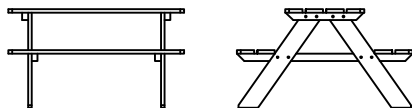

Zestaw montażowy! Fixing parts! Kit de montage! Montageset!

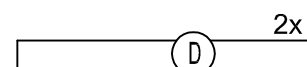
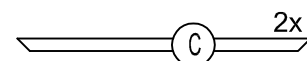
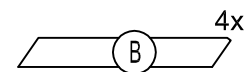
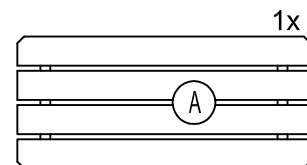
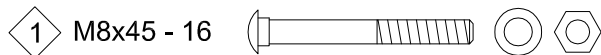

UWAGA! ATTENTION! ACHTUNG!

PL: Przed montażem należy utwardzić i wypoziomować podłoże.

Zaleca się nawiercenie otworów pod wkręty!

EN: Before assembling there is need to toughen and niveler the basis.

For all screws we advise to pre-bore the holes!

FR: Avant le montage, il est conseillé de tasser et de niveler le sol.

Pour tous les assemblages à l'aide des vis, nous vous conseillons de faire des pré-perçages.

DE: Vor der Montage verfestigen und nivellieren Sie bitte den Boden.

Vor dem Schraubeneindreihen soll man die Löcher bohren!

1

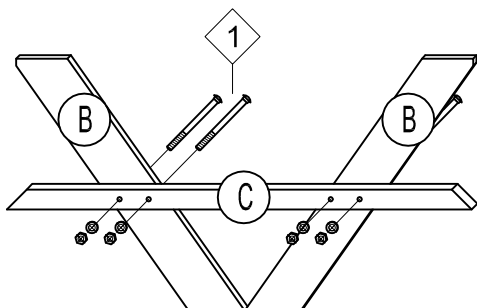

2

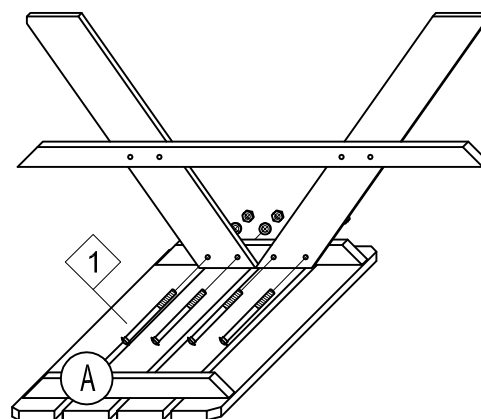

3

