

ENDURA® FLOOD

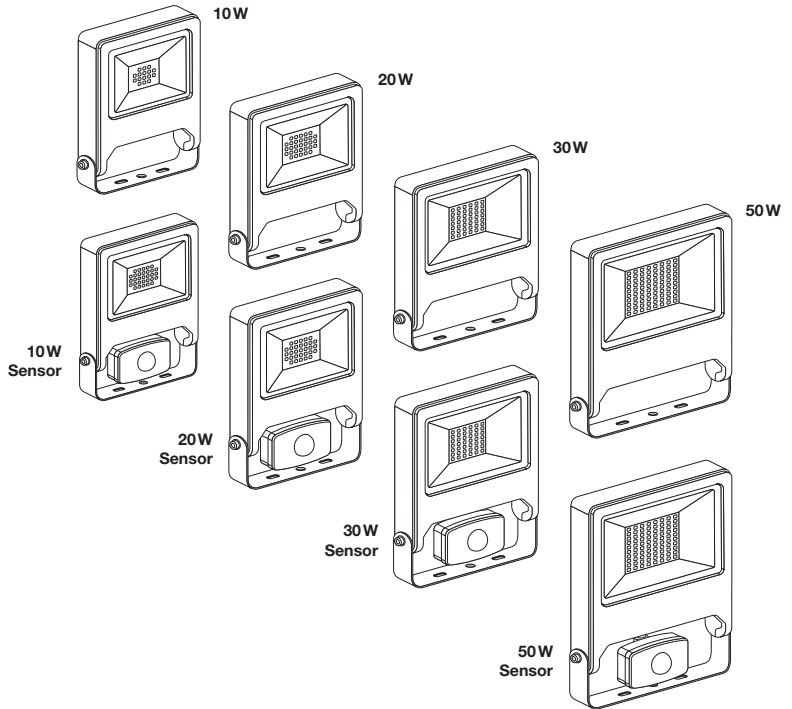

	EAN	W	lm	K	°(°C)	V~	mA	Hz	PF
ENDURA® FLOOD 10W 830 DG	4058075237926	10	800	3000	-20...+45	220-240	46	50/60	≥0.9
ENDURA® FLOOD 20W 830 DG	4058075237940	20	1700	3000	-20...+45	220-240	92	50/60	≥0.9
ENDURA® FLOOD 30W 830 DG	4058075237964	30	2700	3000	-20...+45	220-240	145	50/60	≥0.9
ENDURA® FLOOD 50W 830 DG	4058075239340	50	4500	3000	-20...+45	220-240	220	50/60	≥0.9
ENDURA® FLOOD SENSOR 10W 830 DG	4058075292154	10	800	3000	-10...+40	220-240	46	50/60	≥0.7
ENDURA® FLOOD SENSOR 20W 830 DG	4058075239500	20	1700	3000	-10...+40	220-240	92	50/60	≥0.9
ENDURA® FLOOD SENSOR 30W 830 DG	4058075239548	30	2700	3000	-10...+40	220-240	145	50/60	≥0.9
ENDURA® FLOOD SENSOR 50W 830 DG	4058075239593	50	4500	3000	-10...+40	220-240	220	50/60	≥0.9

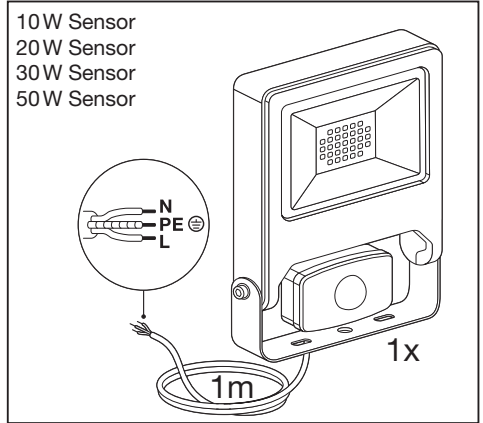

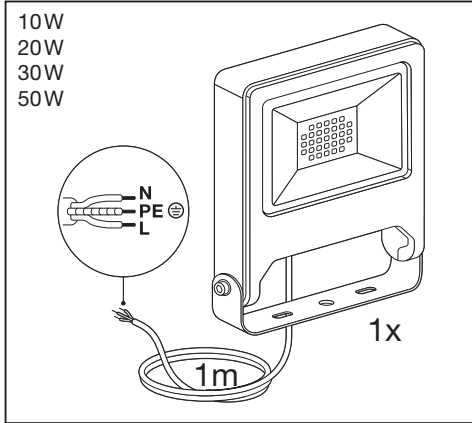

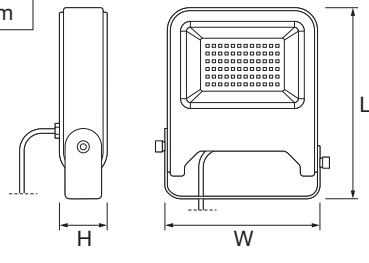
mm

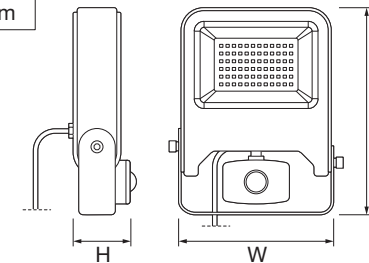

	L	W	H	
Flood 10W	122	108	33	280g
Flood 20W	153	133	34	405g
Flood 30W	193	170	39	650g
Flood 50W	245	210	43	1070g

mm



	L	W	H	
Flood 10W Sensor	168	108	63	380g
Flood 20W Sensor	189	133	66	490g
Flood 30W Sensor	223	170	66	720g
Flood 50W Sensor	267	210	70	1150g

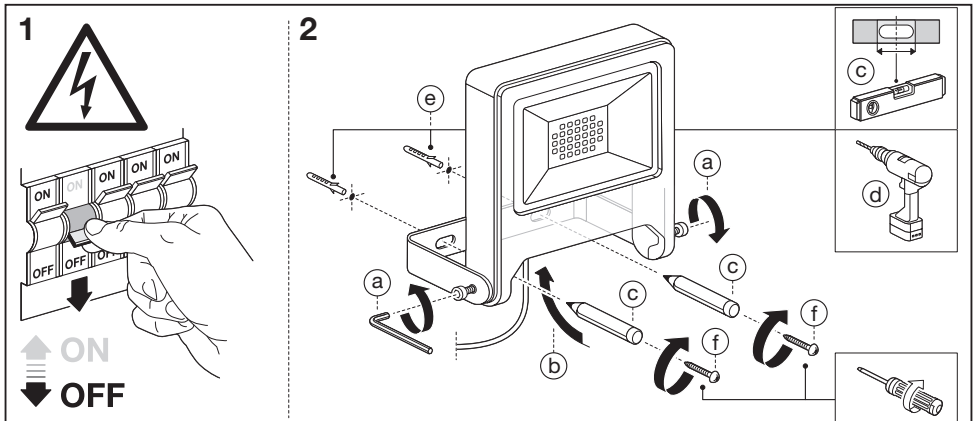

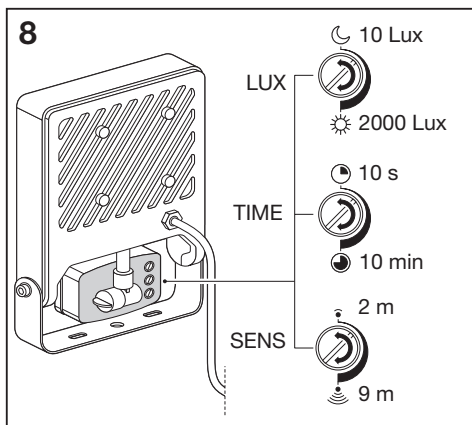
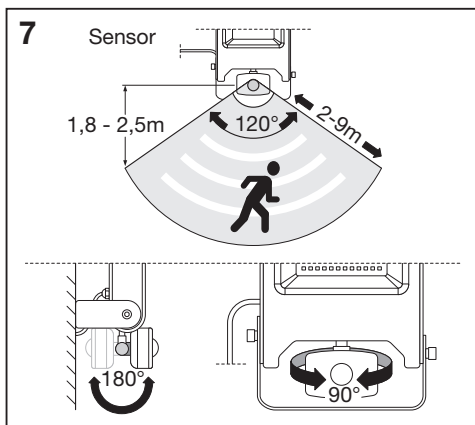
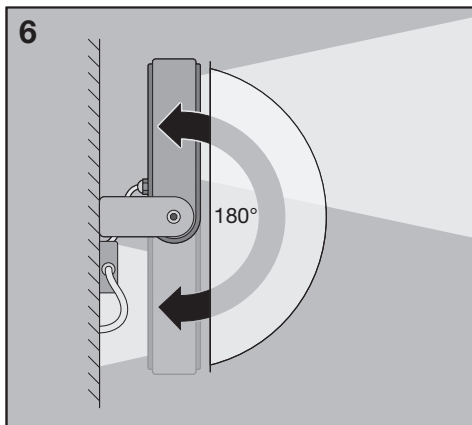
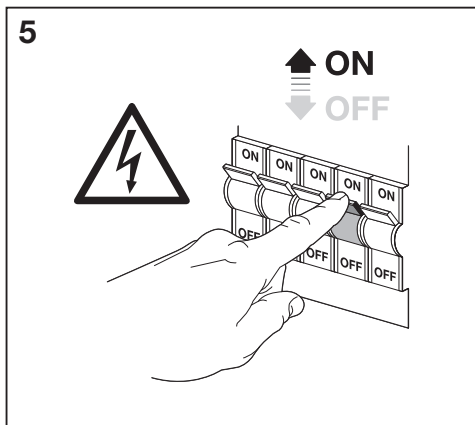
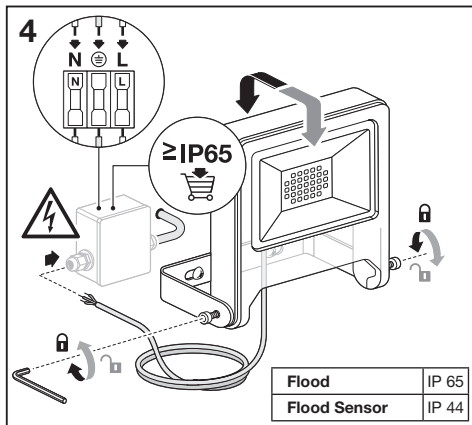
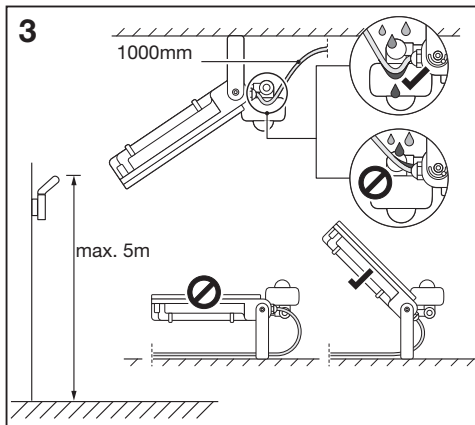



LEDVANCE GmbH
Steinerne Furt 62
86167 Augsburg, Germany
www.ledvance.com